



Tilda®

LAZY DAYS  
FAN FLOWER QUILT  
2 colorways

# Fan Flower Quilt

## (Blue/coral version)

This fun quilt features bold flowers created using an easy Dresden wedge technique for the petals, plus a simple leaf block made from half-rectangle triangle units. Some turned-edge appliqué adds to the charming look. The quilt uses mainly blue and coral fabrics, mostly from the Lazy Days range. There is also a version of the quilt using predominantly pink and green colours.

### Materials

- Fabric 1: 1yd (1m) – Solid lilac (120030)
- Fabric 2: 1yd (1m) – Solid night blue (120029)
- Fabric 3: 1yd (1m) – Solid salmon (120027)
- Fabric 4: 1½yd (1.2m) – Pen Stripe grey (130033)
- Fabric 5: ¼yd (25cm) – Josephine sand (100161)
- Fabric 6: ¼yd (25cm) – Phoebe ginger (100162)
- Fabric 7: ¼yd (25cm) – Mildred ginger (100163)
- Fabric 8: ¼yd (25cm) – Eleanore coral (100164)
- Fabric 9: ¼yd (25cm) – Frances pink (100165)
- Fabric 10: ⅔yd (40cm) – Trickles teal (130050)
- Fabric 11: ¼yd (25cm) – Eleanore teal (100176)
- Fabric 12: ¼yd (25cm) – Josephine teal (100177)
- Fabric 13: ¼yd (25cm) – Phoebe emerald (100178)
- Fabric 14: ¼yd (25cm) – Mildred green (100179)
- Fabric 15: ¼yd (25cm) – Frances teal (100180)
- Fabric 16: ⅔yd (40cm) – Trickles coral (130049)
- Fabric 17: ¼yd (25cm) – Eleanore lilac (100166)
- Fabric 18: ⅔yd (40cm) – Josephine emerald (100167)
- Fabric 19: ¼yd (25cm) – Frances lilac (100168)
- Fabric 20: ¼yd (25cm) – Phoebe thistle (100169)
- Fabric 21: 8in (20.3cm) square – Mildred lilac (100170)
- Fabric 22: ⅔yd (40cm) – Trickles blue (130051)
- Fabric 23: ¼yd (25cm) – Frances blue (100171)
- Fabric 24: ¼yd (25cm) – Eleanore blue (100172)
- Fabric 25: ¼yd (25cm) – Mildred blue (100173)
- Fabric 26: ⅔yd (40cm) – Josephine blue (100174)
- Fabric 27: 8in (20.3cm) square – Phoebe blue (100175)
- Fabric 28: ⅔yd (40cm) – Trickles lilac (130053)
- Backing fabric 3⅔yd (3.3m)
- Wadding (batting) 64in x 79in (163cm x 200cm)
- Binding fabric ½yd (50cm) – Solid lime green (120028)
- Erasable marker
- Thick card for templates
- Piecing and quilting threads
- Quilter's ruler, rotary cutter and mat

**Fabric note:** Where a long quarter of a yard is given in the Materials list you could use a fat quarter instead, which is assumed to be approximately 21in x 18in (53.3cm x 45.7cm).

## Finished Size

55in x 70in (140cm x 178cm)

## Notes

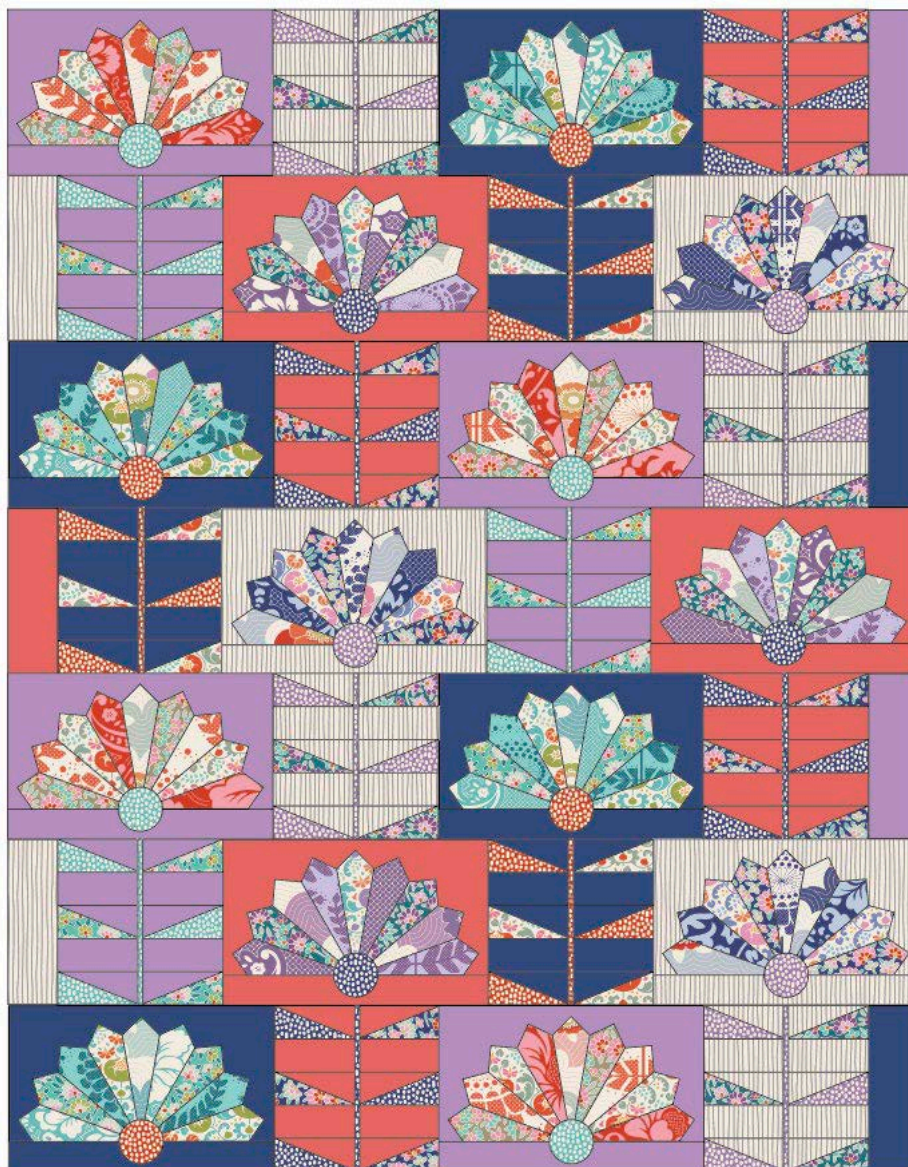
- Fabric quantities given are based on a usable width of 42in (107cm).
- Measurements are in imperial inches with metric conversions in brackets – use only one system throughout (preferably imperial).
- Press all fabrics before use.
- Use ¼in (6mm) seams unless otherwise instructed.
- Read all the instructions through before you start.

## Preparation and Cutting Out

1 This quilt is made up of two blocks, a Flower block and a Leaf block, each sewn in four different fabric combinations. Vertical sashing strips bring each row of the quilt up to the same size. The fabrics used are shown in **Fig A** and the quilt layout in **Fig B**.

**Fig A** Fabric swatches (blue/coral quilt)



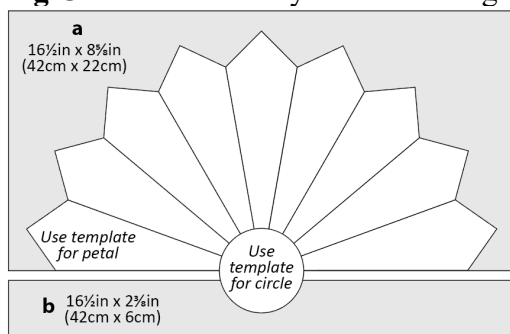
**Fig B** Quilt layout

**2** Each Flower block has two pieces of background fabric, **a** and **b** – see **Fig C** for the layout and sizes. The flower petals are cut using a petal template from a fabric strip  $7\frac{1}{4}$ in (18.4cm) high. The circle is made using turned-edge appliqué. The fabrics used for the four colourways of the Flower block are shown in **Fig D**. A list of the cut pieces needed for one block is given in Making a Flower Block (Step 8).

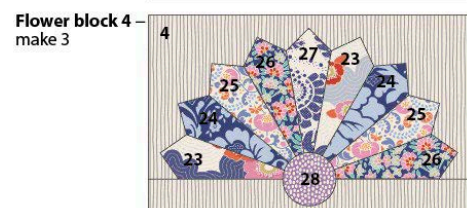
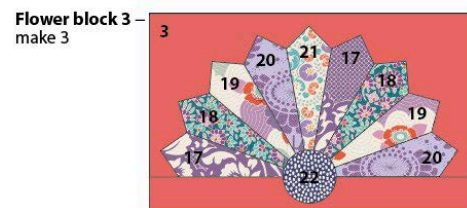
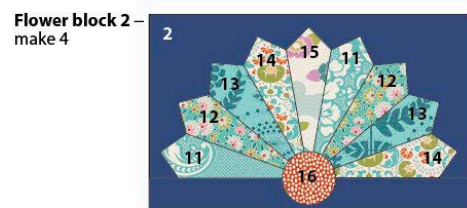
**3** Each Leaf block is made up of rectangles (**c**) cut  $5\frac{1}{2}$ in x  $2\frac{1}{2}$ in (14cm x 6.4cm) – see **Fig E** for the layout and sizes. Each block needs ten rectangles of background fabric, three rectangles from one print fabric and three rectangles from another print fabric. Some of the rectangles are used to make half-rectangle triangle (HRT) units. The centre stem (**d**) is made from an appliqué strip. The fabrics used for the four colourways for the Leaf block are shown in **Fig F**. A list of the cut pieces needed for one block is given in Making a Leaf Block (Step 16).

**4** For the sashing strips cut pieces  $3\frac{1}{2}$ in x  $10\frac{1}{2}$ in (9cm x 26.7cm), cutting two each from Fabric 1, Fabric 2 and Fabric 4, and one from Fabric 3.

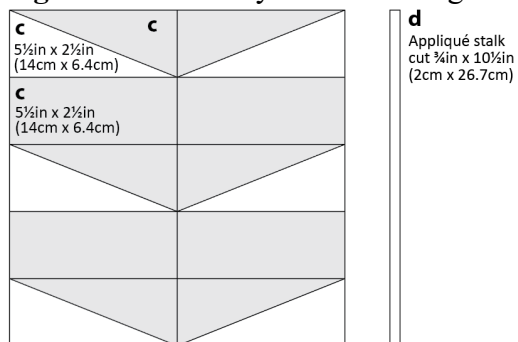
**Fig C Flower block layout and cutting**



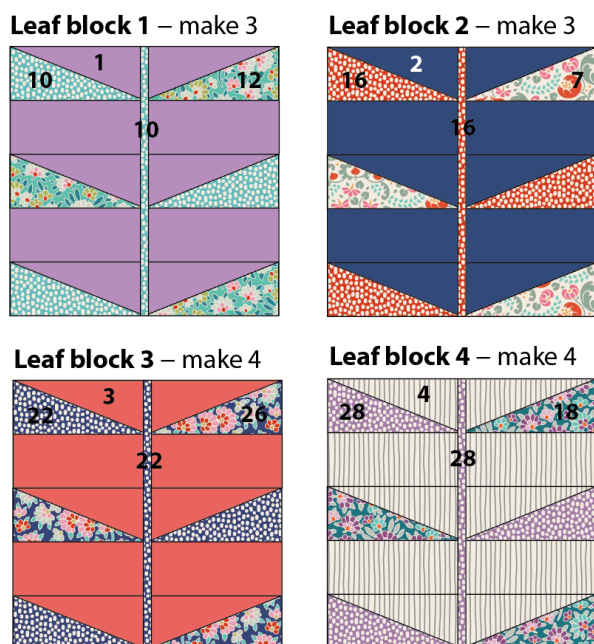
**Fig D Flower block colourways**  
Numbers indicate fabrics



**Fig E Leaf block layout and cutting**



**Fig F** Leaf block colourways  
Numbers indicate fabrics



**5** Cut the backing fabric in half across the width. Sew the pieces together along the long side. Press the seam open and trim to a piece about 64in x 79in (163cm x 200cm).

**6** From the binding fabric cut seven strips  $2\frac{1}{2}$ in (6.4cm) x width of fabric. Sew together end to end and press the seams open. Press in half along the length, wrong sides together.

**7** Copy the petal template and the small and large circle templates onto thick card and cut out the shapes.

### Making a Flower Block

**8** All of the Flower blocks are made the same way. Detailed instructions and diagrams are given for making a Flower block 1. For one Flower block 1 you will need the following pieces (see also **Fig C** and **Fig D**).

- From Fabric 1, one background piece **a** –  $16\frac{1}{2}$ in x  $8\frac{5}{8}$ in (42cm x 22cm).
- From Fabric 1, one background piece **b** –  $16\frac{1}{2}$ in x  $2\frac{3}{8}$ in (42cm x 6cm).
- From Fabric 5, two petals, cut using the petal template (see next step).
- From Fabric 6, two petals.
- From Fabric 7, two petals.
- From Fabric 8, two petals.
- From Fabric 9, one petal.
- From Fabric 10, one circle, cut using the large circle template.

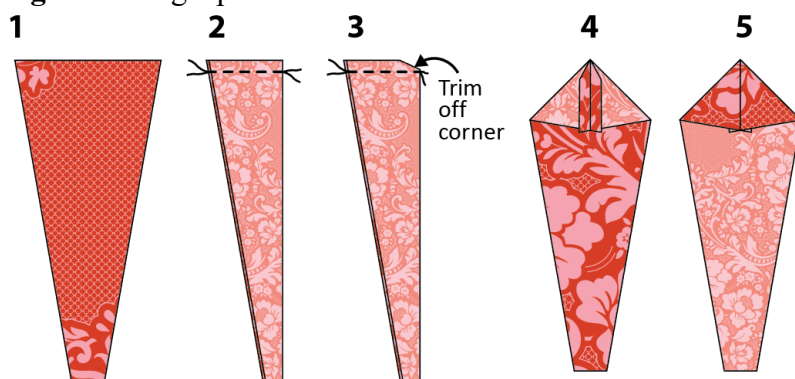
**9** To cut petals, take a  $7\frac{1}{4}$ in (18.4cm) high fabric strip, place the petal template on the fabric and mark the shape (**Fig G**). Rotate the template 180 degrees and mark another shape. Use a normal quilting ruler to cut out the shapes accurately. Repeat this process with the other fabrics to cut the petals needed.

**10** To create a petal follow the sequence in **Fig H**. Take a petal, fold the shape in half vertically, right sides together and align the top edges. Sew a  $\frac{1}{4}$ in (6mm) seam along the top. Trim a small triangle from the seam allowance. Open up the top of the petal and press the seam open. Turn the petal right side out, poke out the top point with a pointed stick or similar tool and then press again. Repeat this to make all nine petals for one Flower block 1.

**Fig G** Marking petals using the template



**Fig H** Making a petal

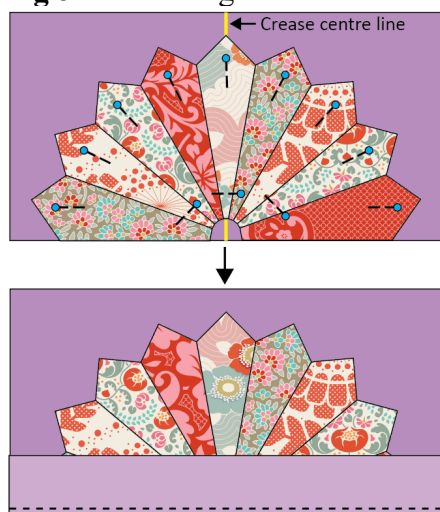


**11** Lay out the nine petals in the order shown in **Fig D**. Take the first two petals, place them right sides together and sew the side seam. Press the seam open or to one side. Continue like this, sewing all of the petals together and then press (**Fig I**).

**12** To assemble the block, take a  $16\frac{1}{2}$ in x  $8\frac{5}{8}$ in (42cm x 22cm) piece of Fabric 1, fold it in half vertically and press a light crease. Position the petal unit on the fabric, lining up the centre of the petal unit with the creased line and with the bottom edges aligned, as in **Fig J**. Pin the petal unit in position. Take a  $16\frac{1}{2}$ in x  $2\frac{3}{8}$ in (42cm x 6cm) piece of Fabric 1, place it right sides together with the bottom of the block, as shown. Sew together using a  $\frac{1}{4}$ in (6mm) seam and press.

**Fig I** Sewing the petals together

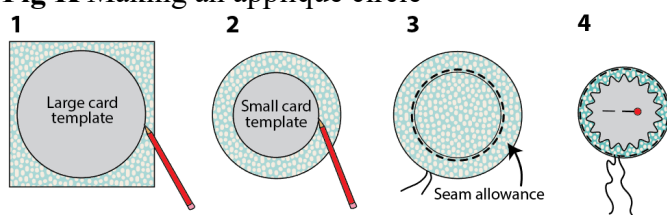
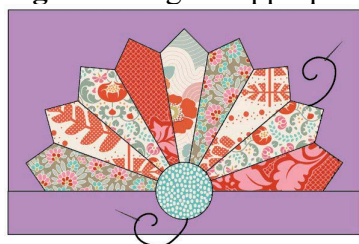


**Fig J** Assembling a Flower block

**13** Make an appliqué circle following the stages shown in **Fig K**. Use the large circle template to cut a 4in (10.2cm) diameter circle from Fabric 10 (for Flower block 1). This size allows for a seam allowance of about  $\frac{3}{4}$ in (2cm) all round. Place the smaller circle template in the centre of a fabric circle and use a pencil to mark the circle. Use a doubled thread to sew a circle of gathering stitches about  $\frac{1}{8}$ in (3mm) *outside* of the marked line. Place the small card circle back onto the fabric and pin in place. Pull up the gathering threads, to gather the fabric around the card. Tie off the threads and press well. Remove the card and press again. You can leave the gathering thread in place if it doesn't show.

**14** Place the appliqué circle onto the Flower block, in the position shown in **Fig L**. Sew the petal unit and the circle into place using matching thread and tiny slip stitches around the edges of the shapes. Press the block and check it is  $16\frac{1}{2}$ in x  $10\frac{1}{2}$ in (42cm x 26.7cm). Repeat this process to make a total of four Flower block 1.

**15** Repeat this whole process to make the rest of the Flower blocks, following the fabrics and numbers of blocks given in **Fig D**.

**Fig K** Making an appliqué circle**Fig L** Sewing the appliqués in place



## Making a Leaf Block

**16** All of the Leaf blocks are made the same way. Detailed instructions and diagrams are given for making a Leaf block 1. For one Leaf block 1 you will need the following pieces (see also **Fig E** and **Fig F**).

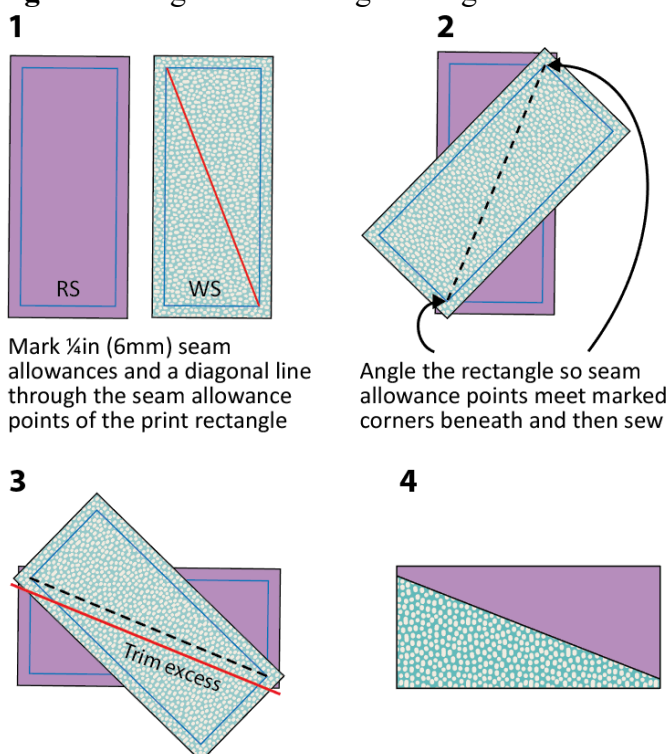
- From Fabric 1, four of piece **c** – 5½in x 2½in (14cm x 6.4cm).
- From Fabric 1, six of piece **c** for HRT units.
- From Fabric 10, three of piece **c** for HRT units.
- From Fabric 12, three of piece **c** for HRT units.
- From Fabric 10, one strip **d** for a stem – ¾in x 10½in (2cm x 14cm).

**17** To make a half-rectangle triangle unit, take a 5½in x 2½in (14cm x 6.4cm) rectangle of Fabric 1 and of Fabric 10. Use an erasable marker to mark the ¼in (6mm) seam allowance all round on the right side (RS) of Fabric 1 and the wrong side (WS) of Fabric 10 (see **Fig M 1**). On Fabric 10, mark a diagonal line that bisects the seam allowance (*not* the outer corners of the shape). Place the diagonally marked rectangle right sides together with the other rectangle, angling the top piece so the seam allowance corners are aligned as in **Fig M 2**. Pin in place and then sew along the marked line (you can sew to the edges of the fabric if you like). Trim off excess fabric ¼in (6mm) away from the sewn line (**Fig M 3**). Flip the triangle over and press it into place. Check the unit is 5½in x 2½in (14cm x 6.4cm).

**18** Make another HRT like this using Fabrics 1 and 10 and then make one unit using Fabrics 1 and 12.

**19** Make three more HRT units for the other half of the block (one with Fabrics 1 and 10 and two with Fabrics 1 and 12). These units have to face the *opposite* way, so draw the diagonal line facing the opposite way, and angle the top piece the opposite way, so the final unit will have its diagonal line slanting in the opposite direction.

**Fig M** Making a half-rectangle triangle unit

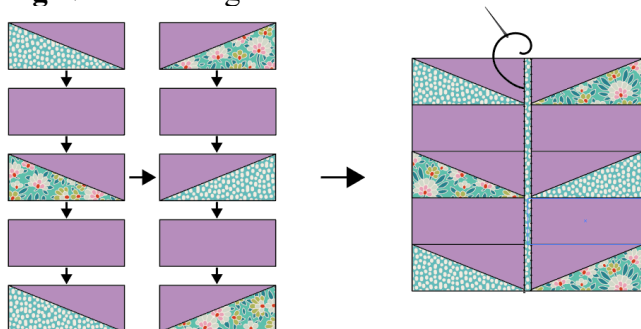


**20** Take the ten units for the block and lay them out as in **Fig N**. Sew them together in columns and then sew the columns together and press. Check the block is 10½in (26.7cm) square.

**21** For the stem, take a ¾in x 10½in (2cm x 26.7cm) strip of Fabric 10. Fold each long edge over to the wrong side by ¼in (6mm) and press. Now fold the strip in half along the length, so it is about ¼in (6mm) wide and press. Sew the stem into place down the centre of the block using matching thread and tiny slip stitches along the long edges and press.

**22** Repeat this process to make the rest of the Leaf blocks, following the fabrics and numbers of blocks given in **Fig F**.

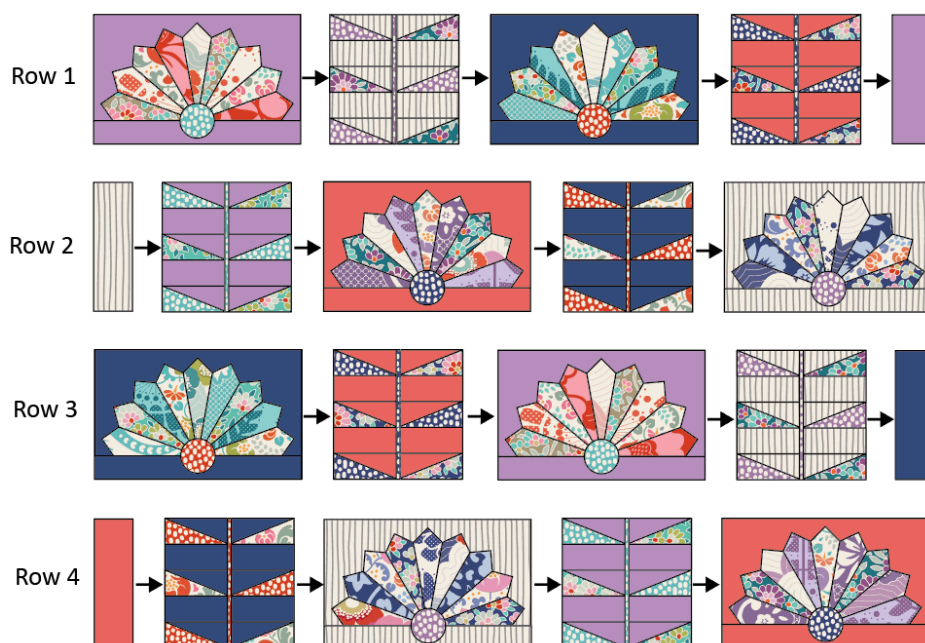
**Fig N** Assembling a Leaf block



### Assembling the Quilt

**23** Take the Flower blocks, the Leaf blocks and the seven 3½in x 10½in (9cm x 26.7cm) sashing pieces. Lay out the first four rows of the quilt as shown in **Fig O**. Sew each row together, pressing the seams of Rows 1 and 3 in the opposite direction to Rows 2 and 4. Now sew the four rows together and press. Add the remaining three rows in the same way, following the layout in **Fig B** (the first three rows, repeated).

**Fig O** Assembling the quilt rows



## Quilting and Finishing

**24** If you are quilting the quilt yourself you now need to make a quilt sandwich – you can do this in various ways, as follows.

- Use large stitches to tack a grid through the layers of the quilt in both directions, with lines about 4in (10cm) apart.
- Use pins or safety pins to fix the layers together.
- Use fabric glue, sprayed onto the wadding to fix the layers together.

If you are sending the quilt off to be commercially long-arm quilted you won't need to make a sandwich, as this is done when the quilt is mounted on the machine. When the layers of the quilt are secured you can quilt as desired.

**25** Use the prepared double-fold binding strip to bind your quilt. Sew the binding to the quilt by pinning the raw edge of the folded binding against the raw edge of the quilt. Don't start at a corner. Using a  $\frac{1}{4}$ in (6mm) seam, sew the binding in place, starting at least 6in (15.2cm) away from the end of the binding. Sew to within a  $\frac{1}{4}$ in (6mm) of a corner and stop. Take the quilt off the machine and fold the binding upwards, creating a mitred corner. Hold this in place, fold the binding back down and pin it in place. Begin sewing the  $\frac{1}{4}$ in (6mm) seam again from the top of the folded binding to within  $\frac{1}{4}$ in (6mm) of the next corner and then repeat the folding process. Do this on all corners. Leave a 6in (15.2cm) 'tail' of unsewn binding at the end.

**26** To join the two ends of the binding, open up the beginning and end of the binding tails, lay them flat and fold the ends back so the two ends touch. Mark these folds by creasing or with pins – this is where your seam needs to be. Open out the binding and sew the pieces together at these creases. Trim off excess fabric and press the seam. Re-fold the binding and finish stitching it in place on the front of the quilt.

**27** With the quilt right side up, use a medium-hot iron to press the binding outwards all round. Now begin to turn the binding over to the back of the quilt, pinning it in place. Use matching sewing thread and tiny stitches to slipstitch the binding in place all round, creating neat mitres at each corner. Press the binding and your fabulous quilt is finished.

# Fan Flower Quilt

## (Pink/green version)

This quilt is identical to the main blue/coral version of the quilt, but the four background fabrics have been changed to create a soft pink and green colourway. Where indicated, refer to the instructions and diagrams for the main quilt.

### Materials

- Fabric 1: 1yd (1m) – Solid blue sage (120008)
- Fabric 2: 1yd (1m) – Solid pink (120026)
- Fabric 3: 1yd (1m) – Solid lime green (120028)
- Fabric 4: 1½yd (1.2m) – Pen Stripe light blue (130032)
- Fabric 5: ¼yd (25cm) – Josephine sand (100161)
- Fabric 6: ¼yd (25cm) – Phoebe ginger (100162)
- Fabric 7: ¼yd (25cm) – Mildred ginger (100163)
- Fabric 8: ¼yd (25cm) – Eleanore coral (100164)
- Fabric 9: ¼yd (25cm) – Frances pink (100165)
- Fabric 10: ⅜yd (40cm) – Trickles teal (130050)
- Fabric 11: ¼yd (25cm) – Eleanore teal (100176)
- Fabric 12: ¼yd (25cm) – Josephine teal (100177)
- Fabric 13: ¼yd (25cm) – Phoebe emerald (100178)
- Fabric 14: ¼yd (25cm) – Mildred green (100179)
- Fabric 15: ¼yd (25cm) – Frances teal (100180)
- Fabric 16: ⅜yd (40cm) – Trickles coral (130049)
- Fabric 17: ¼yd (25cm) – Eleanore lilac (100166)
- Fabric 18: ⅜yd (40cm) – Josephine emerald (100167)
- Fabric 19: ¼yd (25cm) – Frances lilac (100168)
- Fabric 20: ¼yd (25cm) – Phoebe thistle (100169)
- Fabric 21: 8in (20.3cm) square – Mildred lilac (100170)
- Fabric 22: ⅜yd (40cm) – Trickles blue (130051)
- Fabric 23: ¼yd (25cm) – Frances blue (100171)
- Fabric 24: ¼yd (25cm) – Eleanore blue (100172)
- Fabric 25: ¼yd (25cm) – Mildred blue (100173)
- Fabric 26: ⅜yd (40cm) – Josephine blue (100174)
- Fabric 27: 8in (20.3cm) square – Phoebe blue (100175)
- Fabric 28: ⅜yd (40cm) – Trickles lilac (130053)
- Backing fabric 3⅝yd (3.3m)
- Wadding (batting) 64in x 79in (163cm x 200cm)
- Binding fabric ½yd (50cm) – Dottie Dots grey (130045)
- Erasable marker
- Thick card for templates
- Piecing and quilting threads
- Quilter's ruler, rotary cutter and mat

**Fabric note:** Where a long quarter of a yard is given in the Materials list you could use a fat quarter instead, which is assumed to be approximately 21in x 18in (53.3cm x 45.7cm).

## Finished Size

55in x 70in (140cm x 178cm)

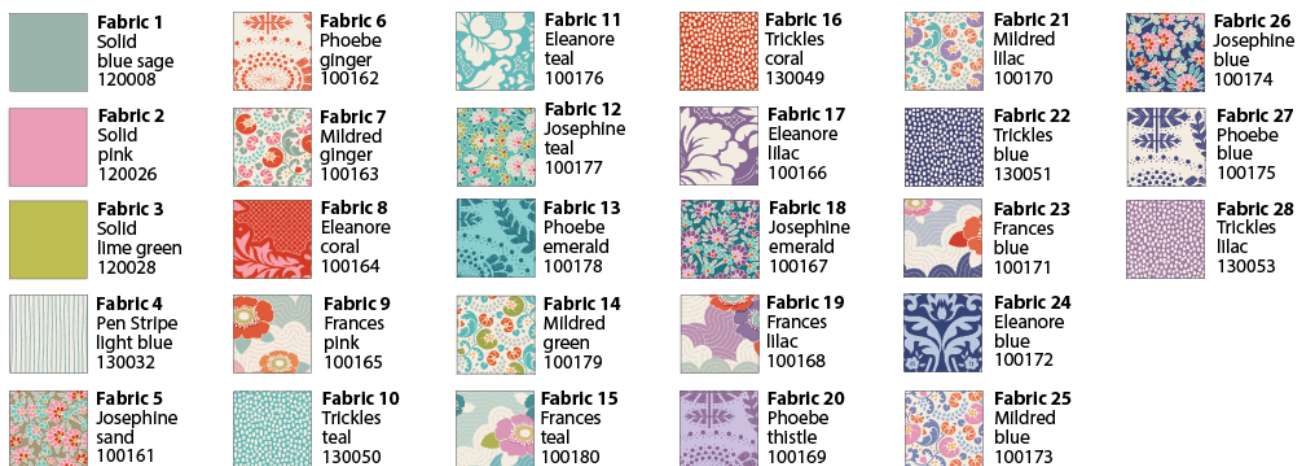
## Notes

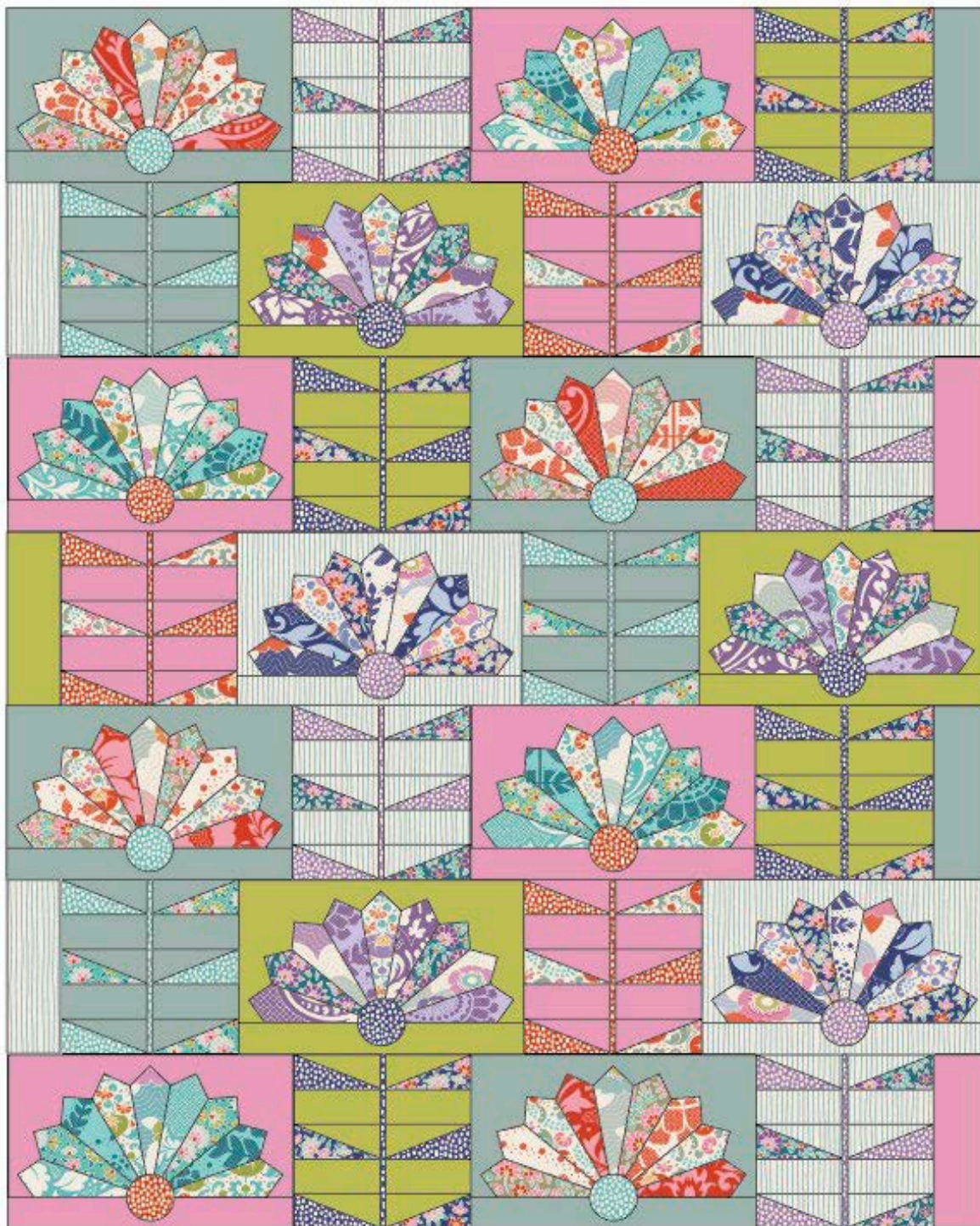
- Fabric quantities given are based on a usable width of 42in (107cm).
- Measurements are in imperial inches with metric conversions in brackets – use only one system throughout (preferably imperial).
- Press all fabrics before use.
- Use ¼in (6mm) seams unless otherwise instructed.
- Read all the instructions through before you start.

## Preparation and Cutting Out

1 This quilt is made up of two blocks, a Flower block and a Leaf block, each sewn in four different fabric combinations. Vertical sashing strips bring each row of the quilt up to the same size. The fabrics used for this quilt are shown in **Fig A** here and the quilt layout is shown in **Fig B**.

**Fig A** Fabric swatches (pink/green quilt)



**Fig B** Quilt layout

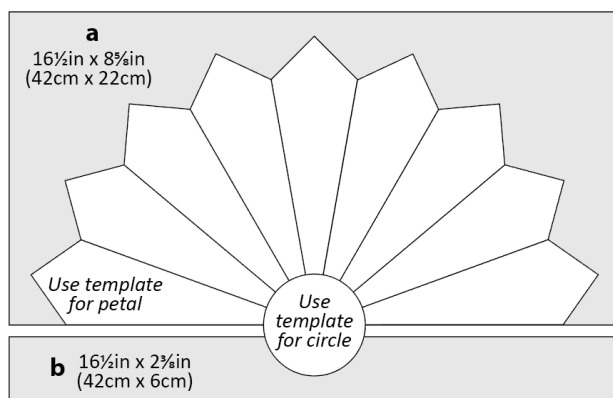
**2** Each Flower block has two pieces of background fabric, **a** and **b** – see **Fig C** for the layout and sizes. The flower petals are cut using a petal template from a fabric strip  $7\frac{1}{4}$ in (18.4cm) high. The circle is made using turned-edge appliqué. The fabrics used for the four colourways of the Flower block are shown in **Fig D** here.

**3** Each Leaf block is made up of rectangles (**c**) cut  $5\frac{1}{2}$ in x  $2\frac{1}{2}$ in (14cm x 6.4cm) – see **Fig E** for the layout and sizes. Each block needs ten rectangles of background fabric, three

rectangles from one print fabric and three rectangles from another print fabric. Some of the rectangles are used to make half-rectangle triangle (HRT) units. The centre stem (**d**) is made from an appliqué strip. The fabrics used for the four colourways for the Leaf block are shown in **Fig F** here.

**4** For the sashing strips cut pieces  $3\frac{1}{2}$ in x  $10\frac{1}{2}$ in (9cm x 26.7cm), cutting two each from Fabric 1, Fabric 2 and Fabric 4, and one from Fabric 3.

**Fig C** Flower block layout and cutting



**Fig D** Flower block colourways  
Numbers indicate fabrics

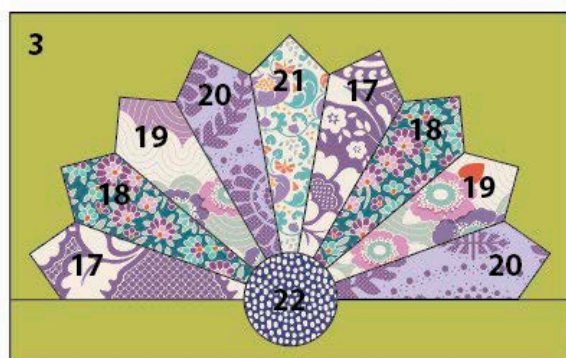
**Flower block 1 – make 4**



**Flower block 2 – make 4**



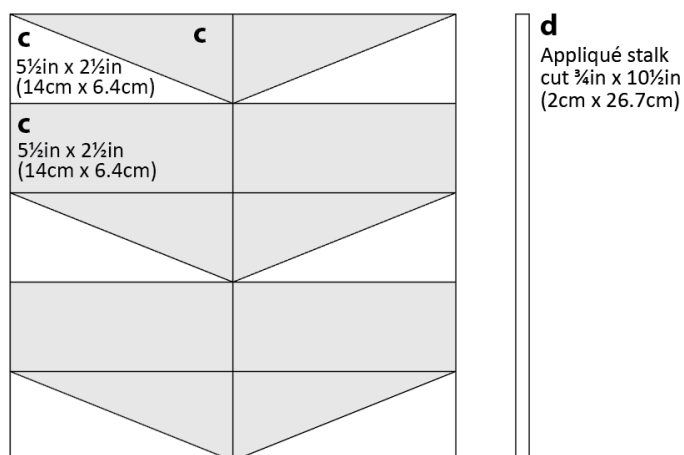
**Flower block 3 – make 3**



**Flower block 4 – make 3**

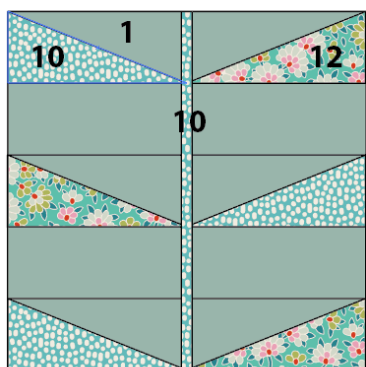


**Fig E** Leaf block layout and cutting

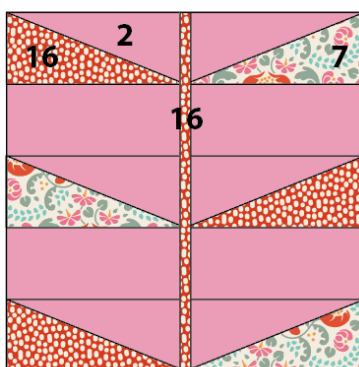


**Fig F** Leaf block colourways  
Numbers indicate fabrics

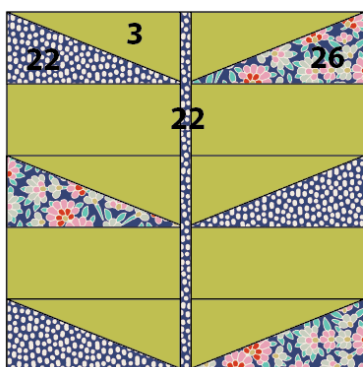
**Leaf block 1 – make 3**



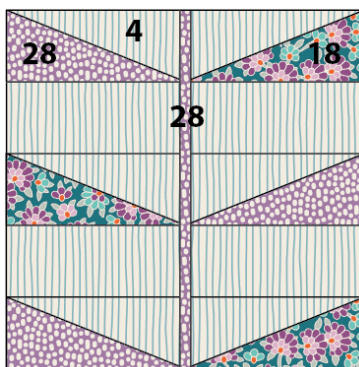
**Leaf block 2 – make 3**



**Leaf block 3 – make 4**



**Leaf block 4 – make 4**



**5** Cut the backing fabric in half across the width. Sew the pieces together along the long side. Press the seam open and trim to a piece about 64in x 79in (163cm x 200cm).

**6** From the binding fabric cut seven strips 2½in (6.4cm) x width of fabric. Sew together end to end and press the seams open. Press in half along the length, wrong sides together.



**7** Copy the petal template and the small and large circle templates onto thick card and cut out the shapes.

### **Making the Flower Blocks**

**8** Make the Flower blocks in the same way as the main blue/coral version of the quilt. Follow Steps 8 to 15, changing the background fabrics as needed to suit this pink/green quilt.

### **Making the Leaf Blocks**

**9** Make the Leaf blocks in the same way as the blue/coral version of the quilt. Follow Steps 16 to 22, changing the background fabrics as needed to suit this pink/green quilt.

### **Assembling and Finishing**

**10** To assemble the quilt, follow Step 23 of the blue/coral version of the quilt. To finish the quilt, follow Steps 24 to 27 of the blue/coral version of the quilt.

# Fan Flower Templates

